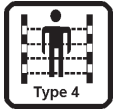

**SAFEasy™ TYPE 4 LIGHT CURTAINS**

- *Integrated light curtains for **BODY PROTECTION***
- *Versions with 2 / 3 / 4 beams*
- *Special slot for device setting*
- *35 x 40 mm compact profile*

## SE4-BODY SERIES

The **SAFEasy™** light curtains, according to the IEC 61496-1 e IEC 61496-2 standards, are suitable for detecting the human body when approaching dangerous areas.

Models with different standard heights (500, 800, 900, 1200 mm), with 2, 3, 4 beams and operating distance reaching 50 m are available.







Specific dip-switches, that can be reached through a slot present on the front of the receiver protected by a lid and opened with a simple screwdriver, guarantee rapid and safe device setting.

The operator is thus able to configure, according to the specific needs, the manual or automatic Restart, as well as the Muting and partial Muting functions.

The emitter-receiver units are optically synchronised and contain all the control circuits, inputs and outputs inside the housing.

A wide range of industrial applications, requiring operator safety, can be solved by the **SAFEasy™** light curtains, thanks to the extremely compact dimensions (35x40 mm) and easy connection and installation.

## TECHNICAL DATA

<b>Power supply:</b> .....	24 Vdc ± 20% (SELV/PELV)
<b>Consumption:</b> .....	70 mA max. / 2.1 W (emitter) 100 mA max. / 3 W (receiver without load)
<b>Light emission:</b> .....	infrared LED 880 nm
<b>Optic diameter:</b> .....	Ø 16 mm
<b>Number of controlled beams:</b> .....	refer to table 1
<b>Optic interaxis:</b> .....	refer to table 2
<b>Resolution:</b> .....	refer to table 2
<b>1st beam installation height:</b> .....	refer to table 3
<b>Through beam operating distance:</b> .....	0.5 ... 25 m (Q vers.) 4 ... 50 m (P vers.)
<b>Receiver inputs:</b> .....	external switches for Muting, Test, Restart and Override
<b>Receiver indicators:</b> .....	green / red SAFE / BREAK LED 2 yellow ALIGNMENT LEDs green POWER ON LED
<b>Emitter indicators:</b> .....	yellow blinking FAILURE LED green POWER ON LED
<b>Output type:</b> .....	2 PNP
<b>Output current:</b> .....	0.7 A max. 0.25 A max. (45°C - 55°C) short-circuit signalling and protection
<b>Response time:</b> .....	14 ms
<b>Selectable functions:</b> .....	Total / partial Muting Manual / Automatic Restart refer to table 4
<b>Time-out period:</b> .....	Muting: 10 minutes Override: 2 minutes
<b>Muting signalling lamp:</b> .....	24 V 3 W min. (125 mA), 7 W max. (300 mA)
<b>Receiver connection:</b> .....	8-pole M12 connector
<b>Emitter connection:</b> .....	4-pole M12 connector
<b>Cable length:</b> .....	50 m max. (with 50 nF capacitive load)
<b>Safety category:</b> .....	type 4
<b>Electrical protection:</b> .....	class 1
<b>Mechanical protection:</b> .....	IP65 IP67 (connector part)
<b>Housing material:</b> .....	aluminium with PC Makrolon plastic caps
<b>Weight:</b> .....	1.2 Kg max. / m of total height
<b>Operating temperature:</b> .....	-10 ... +55 °C
<b>Storage temperature:</b> .....	-25 ... +70 °C
<b>Reference standards:</b> .....	EN 954-1, IEC 61496-1, IEC 61496-2
<b>Other functions:</b> .....	
<b>Certifications:</b> .....	     

## TABLES

Model	Beams
SE4 height 500	2
SE4 height 800	3
SE4 height 900	4
SE4 height 1200	4

**Table 1: NUMBER OF BEAMS**

Model	mm
SE4 height 500	500 / 515
SE4 height 800	400 / 415
SE4 height 900	300 / 315
SE4 height 1200	400 / 415

**Table 2: INTERAXIS / RESOLUTION**

Model	mm
SE4 height 500	400
SE4 height 800	300
SE4 height 900	300
SE4 height 1200	300

**Table 3: 1st BEAM INSTALLATION HEIGHT**

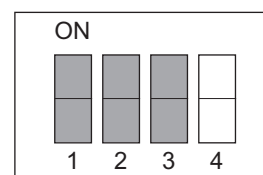

**GREY dip-switches:** total / partial Muting selection  
**WHITE dip-switches:** manual / auto. Restart selection

**Table 4: DIP-SWITCH SELECTION**

## CONNECTIONS

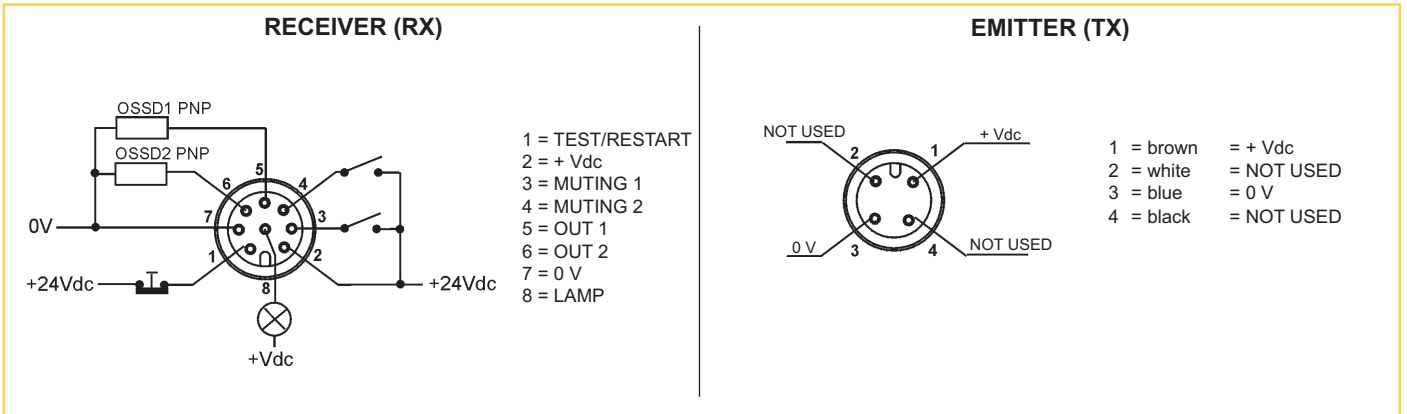

## DIMENSIONS

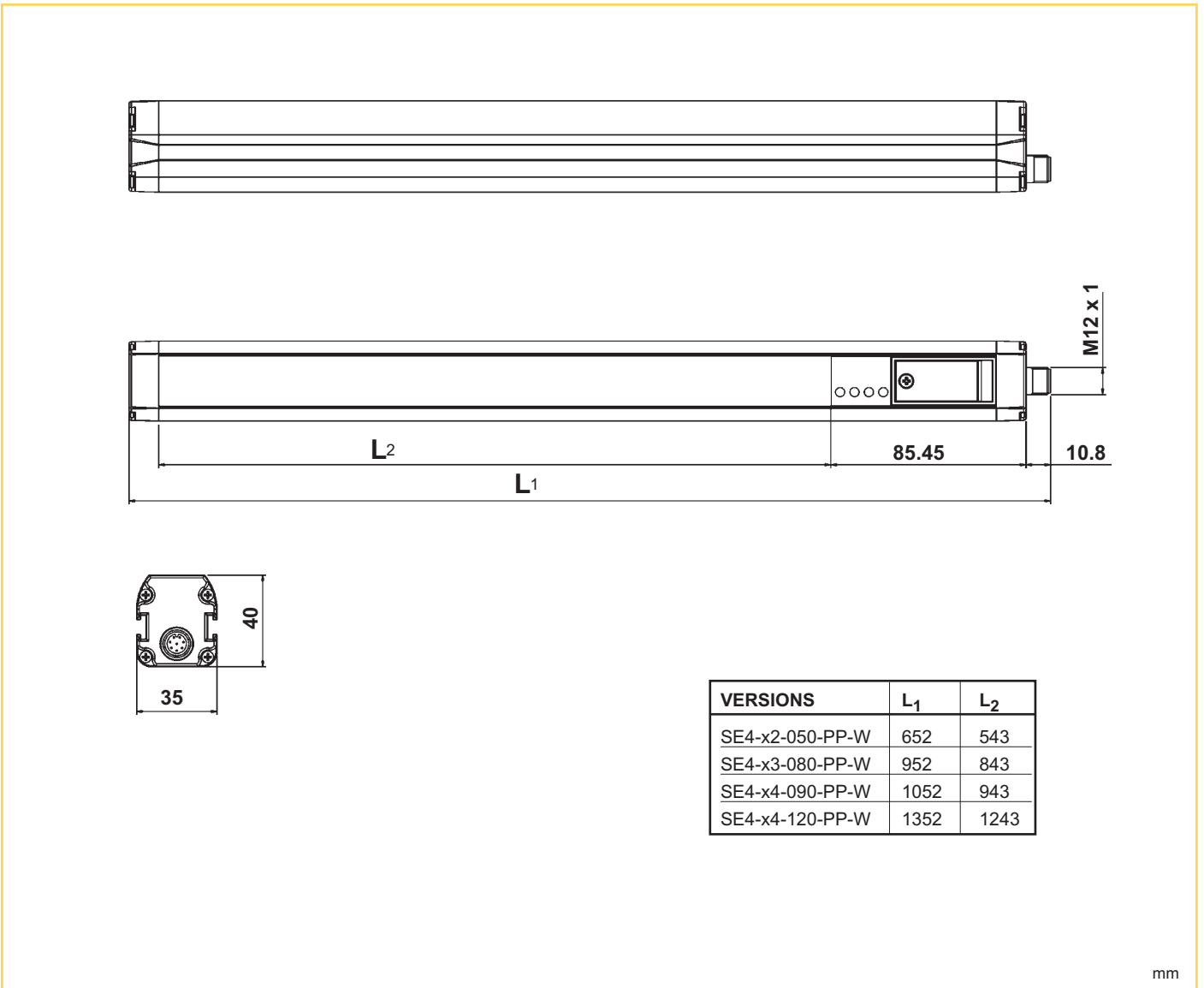

## MODEL SELECTION AND ORDER INFORMATION

MODEL	DESCRIPTION	CODE N°
SE4-P2-050-PP-W	type 4 safety light curtain with 2 beams and 4 ... 50 m op. distance	957201110
SE4-P3-080-PP-W	type 4 safety light curtain with 3 beams and 4 ... 50 m op. distance	957201120
SE4-P4-090-PP-W	type 4 safety light curtain with 4 beams and 4 ... 50 m op. distance	957201130
SE4-P4-120-PP-W	type 4 safety light curtain with 4 beams and 4 ... 50 m op. distance	957201140
SE4-Q2-050-PP-W	type 4 safety light curtain with 2 beams and 0.5 ... 25 m op. distance	957201200
SE4-Q3-080-PP-W	type 4 safety light curtain with 3 beams and 0.5 ... 25 m op. distance	957201210
SE4-Q4-090-PP-W	type 4 safety light curtain with 4 beams and 0.5 ... 25 m op. distance	957201220
SE4-Q4-120-PP-W	type 4 safety light curtain with 4 beams and 0.5 ... 25 m op. distance	957201230

## ACCESSORY SELECTION AND ORDER INFORMATION

Please refer also to *Safety Device Accessories*

**Note: All the accessories have to be ordered separately**

**Distributed by:**

### HEADQUARTERS

#### DATASENSOR SpA

via Lavino, 265 - 40050 Monte San Pietro, BO - Italy  
 Tel. +39 051/6765611 • Fax +39 051/6759324  
 www.datasensor.com • e-mail info@datasensor.com

Datasensor SpA endeavours to continuously improve and renew its products; for this reason the technical data and contents of this catalogue may undergo variations without prior notice. For correct installation and use Datasensor SpA can guarantee only the data indicated in the instruction manual supplied with the products.