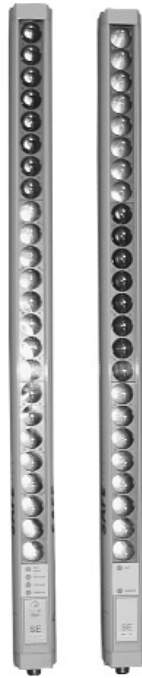

SAFEasy™ TYPE 2 LIGHT CURTAINS

- **Integrated light curtains for HAND PROTECTION**
- **Version with 35 mm resolution**
- **Special slot for device setting**
- **35 x 40 mm compact profile**

SE2-HAND SERIES

The **SAFEasy™** light curtains, according to the IEC 61496-1 e IEC 61496-2 standards, are suitable for hand protection of operators exposed to risks.

Different models with eleven standard heights ranging from 150 to 1650 mm, 35 mm resolution and an operating distance reaching 15 m are available.

Specific dip-switches, that can be reached through a slot present on the front of the receiver protected by a lid and opened with a simple screwdriver, guarantee rapid and safe device setting.



The operator is thus able to configure, according to the specific needs, the manual or automatic Restart, as well as the Muting and partial Muting functions.

The emitter-receiver units are optically synchronised and contain all the control circuits, inputs and outputs inside the housing.

The **SAFEasy™** light curtains have also integrated the test function, automatically activated every second, without stopping the machine's working cycle.

A wide range of industrial applications, requiring operator safety, can be solved by the **SAFEasy™** light curtains, thanks to the extremely compact dimensions (35x40 mm) and easy connection and installation.

TECHNICAL DATA

Power supply:	24 Vdc ± 20% (SELV/PELV)
Consumption:	70 mA max. / 2.1 W (emitter) 100 mA max. (receiver without load)
Light emission:	infrared LED 880 nm
Number of controlled beams:	refer to table 1
Optic interaxis:	18.4 mm
Resolution:	35 mm
Controlled height:	refer to table 2
Through beam operating distance:	0.2 ... 15 m
Receiver inputs:	external switches for Muting, Test, Restart and Override
Receiver indicators:	green / red SAFE / BREAK LED 2 yellow ALIGNMENT LEDs green POWER ON LED
Emitter indicators:	yellow blinking FAILURE LED green POWER ON LED
Output type:	2 PNP
Output current:	0.7 A max. (using both outputs) 0.5 A max. (using one single output) 0.25 A max. (for both outputs from 45°C - 55°C) short-circuit signalling and protection
Response time:	refer to table 3
Selectable functions:	Total / partial Muting manual / automatic Restart refer to table 4
Time-out period:	Muting: 10 minutes Override: 2 minutes
Muting signalling lamp:	24 V 3 W min. (125 mA), 7 W max. (300 mA)
Receiver connection:	8-pole M12 connector
Emitter connection:	4-pole M12 connector
Cable length:	50 m max. (with 50 nF capacitive load)
Safety category:	type 2
Electrical protection:	class 1
Mechanical protection:	IP65 IP67 (connector part)
Housing material:	aluminium with PC Makrolon plastic caps
Weight:	1.2 Kg max. / m of total height
Operating temperature:	-10 ... +55 °C
Storage temperature:	-25 ... +70 °C
Reference standards:	EN 954-1, IEC 61496-1, IEC 61496-2
Certifications:	CE   US LISTED 

TABLES

Model	SE2-35
SE2 height 150	8
SE2 height 300	16
SE2 height 450	24
SE2 height 600	32
SE2 height 750	40
SE2 height 900	48
SE2 height 1050	56
SE2 height 1200	64
SE2 height 1350	72
SE2 height 1500	80
SE2 height 1650	88

Table 1: NUMBER OF BEAMS

Model	SE2-35
SE2 height 150	180
SE2 height 300	327
SE2 height 450	474
SE2 height 600	621
SE2 height 750	768
SE2 height 900	915
SE2 height 1050	1062
SE2 height 1200	1209
SE2 height 1350	1356
SE2 height 1500	1503
SE2 height 1650	1650

Table 2: CONTROLLED HEIGHT (mm)

Model	SE2-35
SE2 height 150	15
SE2 height 300	17
SE2 height 450	18
SE2 height 600	20
SE2 height 750	22
SE2 height 900	23
SE2 height 1050	25
SE2 height 1200	27
SE2 height 1350	28
SE2 height 1500	30
SE2 height 1650	32

Table 3: RESPONSE TIME (ms)

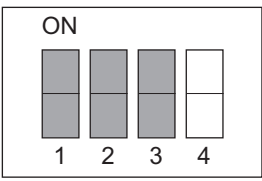

GREY dip-switches: total / partial Muting selection
WHITE dip-switches: manual / auto. Restart selection

Table 4: DIP-SWITCH SELECTION

CONNECTIONS

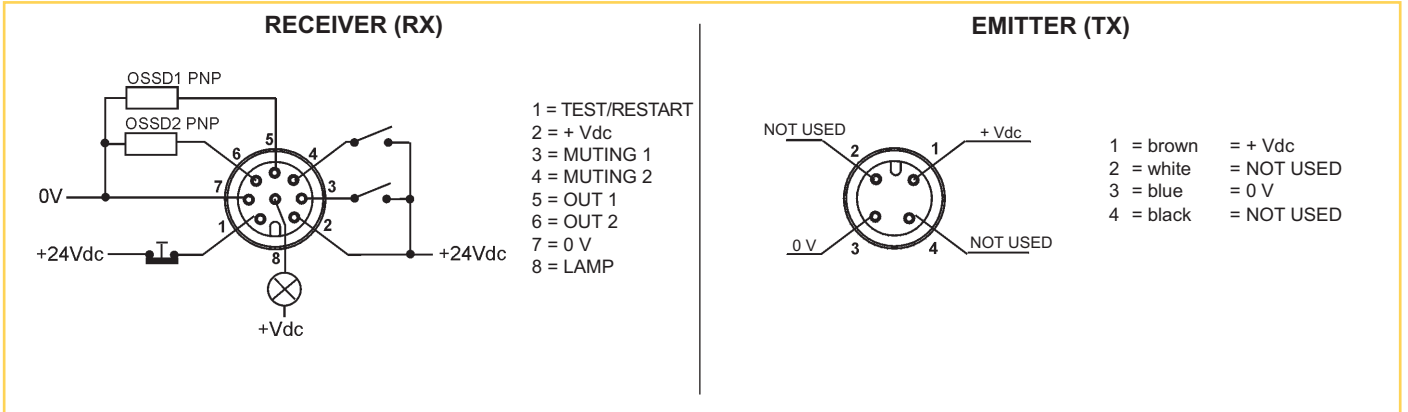

DIMENSIONS

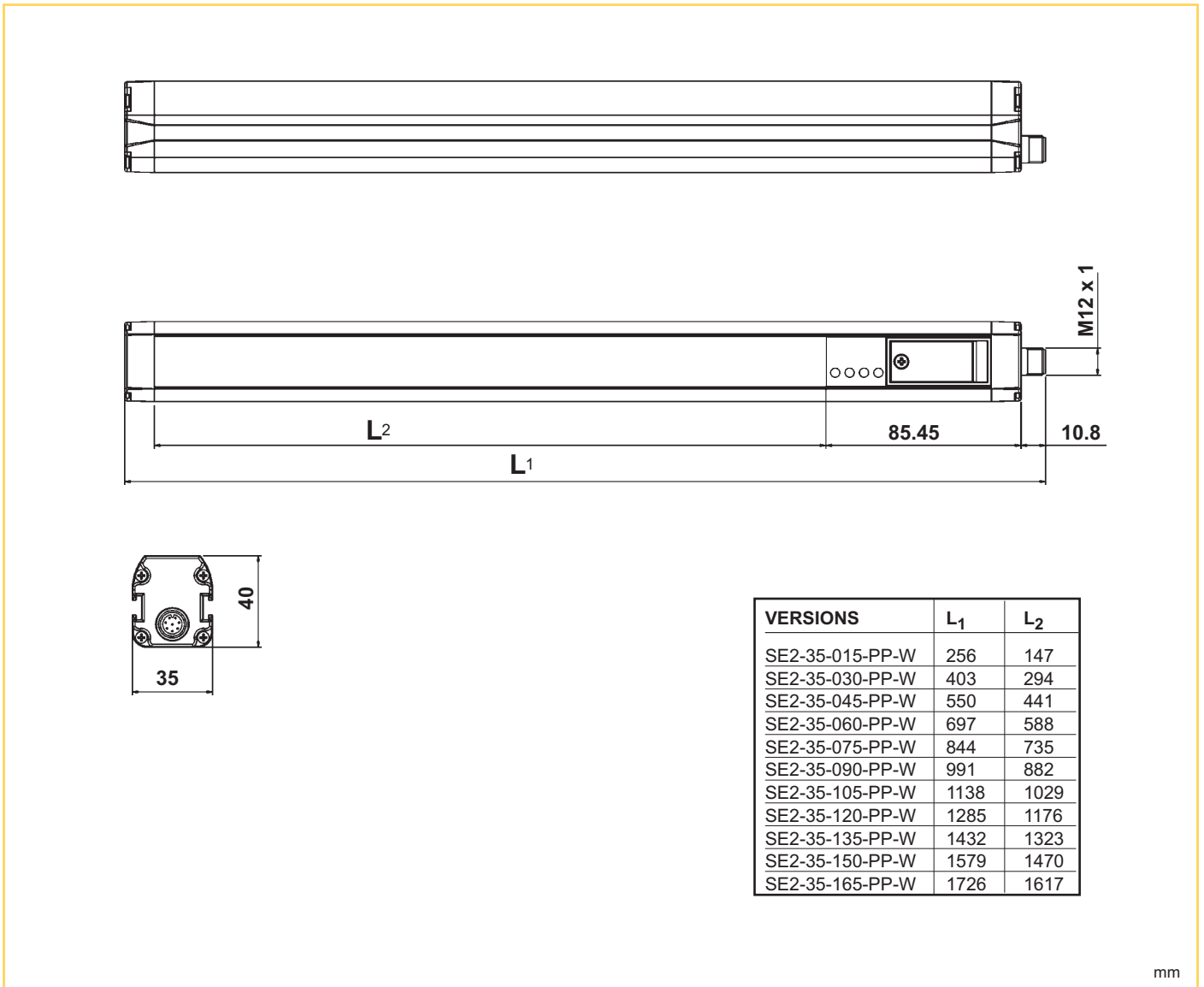



MODEL SELECTION AND ORDER INFORMATION

MODEL	DESCRIPTION	CODE N°
SE2-35-015-PP-W	type 2 safety light curtain h=150 mm	957101000
SE2-35-030-PP-W	type 2 safety light curtain h=300 mm	957101010
SE2-35-045-PP-W	type 2 safety light curtain h=450 mm	957101020
SE2-35-060-PP-W	type 2 safety light curtain h=600 mm	957101030
SE2-35-075-PP-W	type 2 safety light curtain h=750 mm	957101040
SE2-35-090-PP-W	type 2 safety light curtain h=900 mm	957101050
SE2-35-105-PP-W	type 2 safety light curtain h=1050 mm	957101060
SE2-35-120-PP-W	type 2 safety light curtain h=1200 mm	957101070
SE2-35-135-PP-W	type 2 safety light curtain h=1350 mm	957101080
SE2-35-150-PP-W	type 2 safety light curtain h=1500 mm	957101090
SE2-35-165-PP-W	type 2 safety light curtain h=1650 mm	957101100

ACCESSORY SELECTION AND ORDER INFORMATION

Please refer also to *Safety Device Accessories*

Note: All the accessories have to be ordered separately

Distributed by:

HEADQUARTERS

DATASENSOR SpA

via Lavino, 265 - 40050 Monte San Pietro, BO - Italy
Tel. +39 051/6765611 • Fax +39 051/6759324
www.datasensor.com • e-mail info@datasensor.com

Datasensor SpA endeavours to continuously improve and renew its products; for this reason the technical data and contents of this catalogue may undergo variations without prior notice. For correct installation and use Datasensor SpA can guarantee only the data indicated in the instruction manual supplied with the products.