



**APPLICATIONS**

- Automated warehousing
- Reading on forklift trucks
- Picking systems
- Automated shop floor

**ADVANTAGES**

- Extended reading range from 250 to 2000 mm thanks to the "2-step" mechanically adjustable focus system
- DIGITECH™ technology permits full software control over signal processing parameters. Scanner setup can therefore be optimized simply loading optimized software recipes, thus enabling excellent performance in all reading conditions
- ACR4™ reconstruction technology increases the maximum tilt angle and overall read rate on damaged barcodes
- Available with integrated software programmable Oscillating Mirror and built-in connectivity to Ethernet, Profibus and DeviceNet
- Easy and simple configuration thanks to Genius™ multi-language software tool

## HIGHLIGHTS

- Good reading performance on very low contrast bar codes
- Focus adjustable optics
- Reading range from 250 to 2000mm
- ACR4<sup>™</sup> reconstruction technology improves reading of damaged barcodes
- DIGITECH<sup>™</sup> technology enables excellent reading performance
- Linear and integrated Oscillating Mirror versions
- Built-in connectivity to Ethernet / Profibus / DeviceNet
- Display and keyboard for scanner monitoring and diagnostics

## GENERAL DESCRIPTION

DS6300 scanner is designed to offer a complete modular solution in terms of reading performance, built-in connectivity, ease of use and maintenance. With DS6300, Datalogic Automation provides mid-range industrial bar code readers with top class performance.

DS6300 is therefore the optimal solution for a wide range of manufacturing applications both in the automated shop floor and in the automated warehousing.

DS6300 features a practical display with keyboard that increases the scanner's ease of use by showing barcode data read (local echo), statistics and diagnostic information. Moreover, it offers built-in connectivity to Ethernet, DeviceNet and Profibus networks.



## READING DIAGRAMS

### DS6300-100-0XX

Resolution: 0.20 mm/8 mils

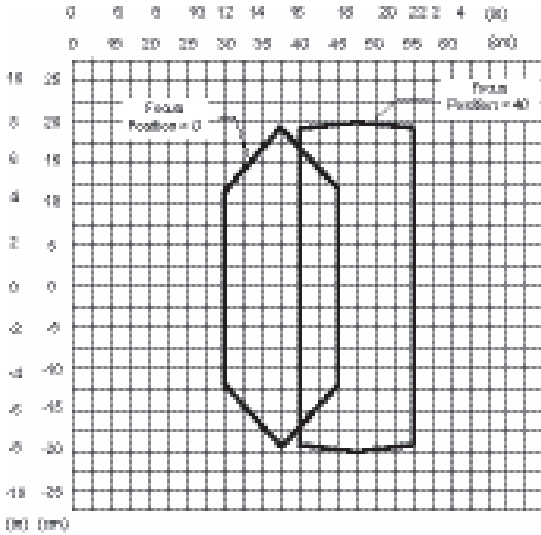

#### CONDITIONS

Code = Interleaved 2/5 or Code 39  
 PCS = 0.90  
 Pitch angle = 0°  
 Skew angle = 10° - 20°  
 Tilt angle = 0°

### DS6300-100-0XX

Resolution: 0.30 mm/12 mils

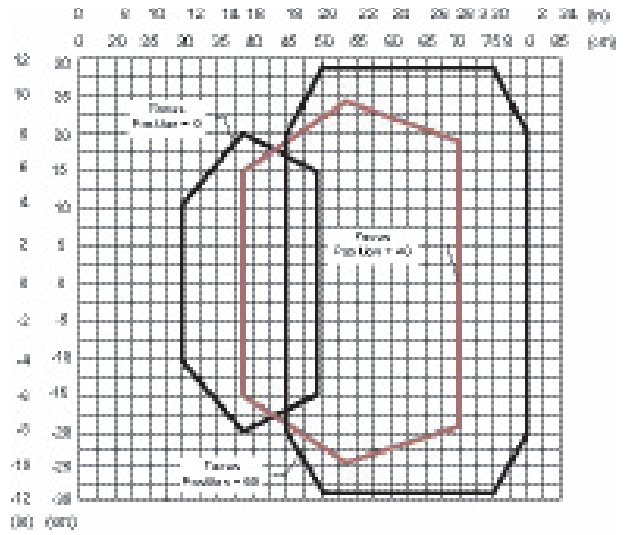

#### CONDITIONS

Code = Interleaved 2/5 or Code 39  
 PCS = 0.90  
 Pitch angle = 0°  
 Skew angle = 10° - 20°  
 Tilt angle = 0°

### DS6300-100-0XX

Resolution: 0.38 mm/15 mils

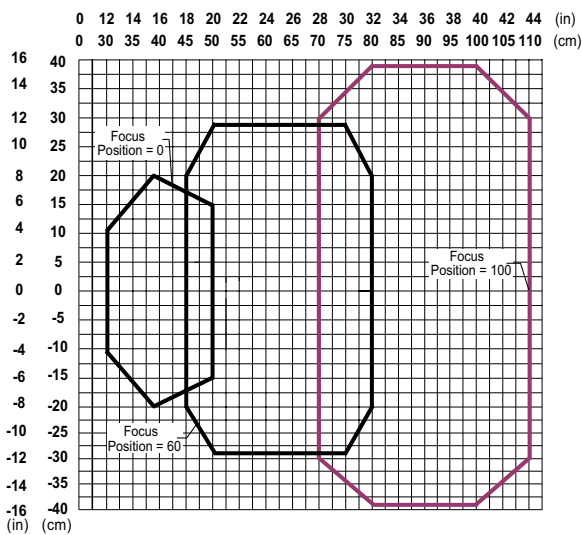

#### CONDITIONS

Code = Interleaved 2/5 or Code 39  
 PCS = 0.90  
 Pitch angle = 0°  
 Skew angle = 10° - 20°  
 Tilt angle = 0°

### DS6300-100-0XX

Resolution: 0.50 mm/20 mils

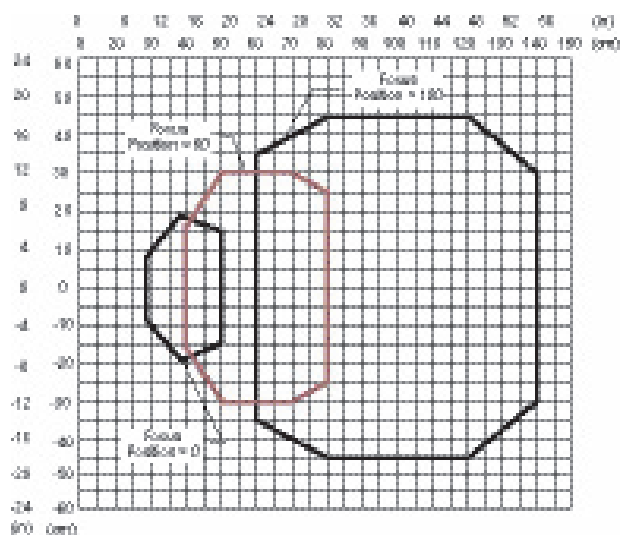

#### CONDITIONS

Code = Interleaved 2/5 or Code 39  
 PCS = 0.90  
 Pitch angle = 0°  
 Skew angle = 10° - 20°  
 Tilt angle = 0°

**READING DIAGRAMS**

**DS6300-105-0XX (Oscillating Mirror)**  
Resolution: 0.20 mm/8 mils

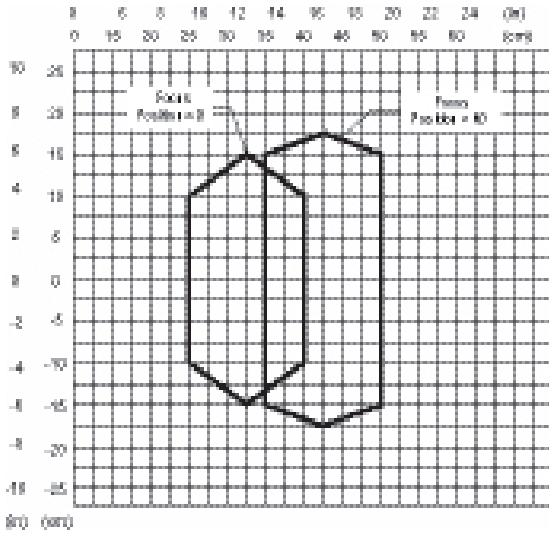

**CONDITIONS**  
Code = Interleaved 2/5 or Code 39  
PCS = 0.90  
Pitch angle = 0°  
Skew angle = 10° - 20°  
Tilt angle = 0

**DS6300-105-0XX (Oscillating Mirror)**  
Resolution: 0.30 mm/12 mils

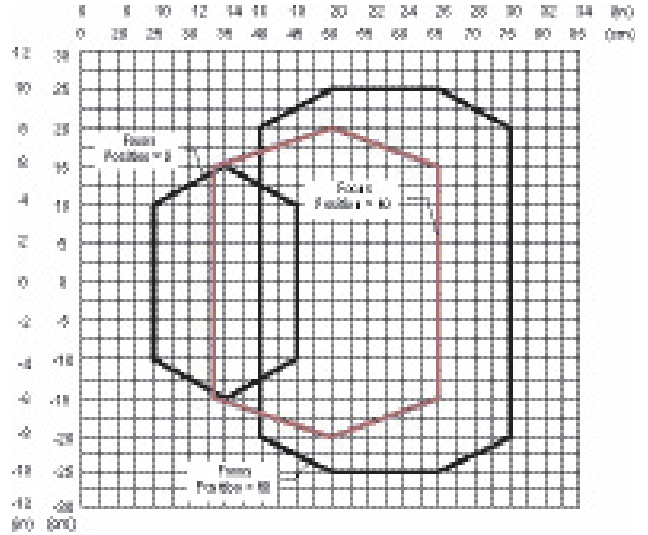

**CONDITIONS**  
Code = Interleaved 2/5 or Code 39  
PCS = 0.90  
Pitch angle = 0°  
Skew angle = 10° - 20°  
Tilt angle = 0°

**DS6300-105-0XX (Oscillating Mirror)**  
Resolution: 0.38 mm/15 mils

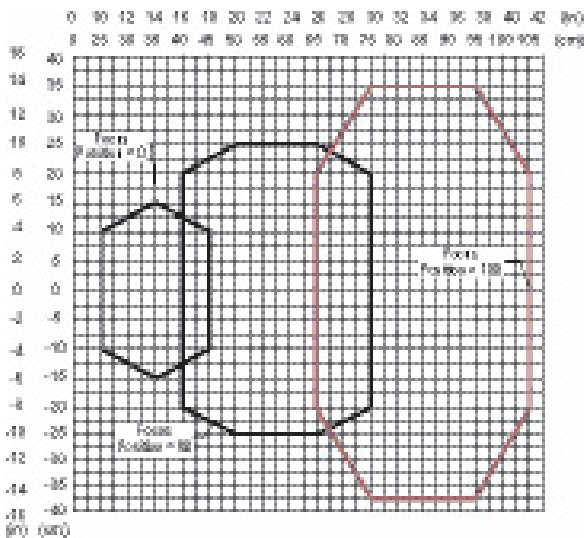

**CONDITIONS**  
Code = Interleaved 2/5 or Code 39  
PCS = 0.90  
Pitch angle = 0°  
Skew angle = 10° - 20°  
Tilt angle = 0°

**DS6300-105-0XX (Oscillating Mirror)**  
Resolution: 0.50 mm/20 mils

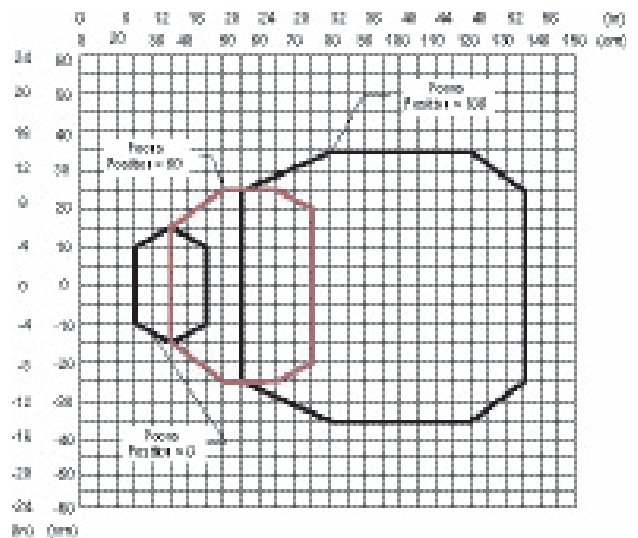

**CONDITIONS**  
Code = Interleaved 2/5 or Code 39  
PCS = 0.90  
Pitch angle = 0°  
Skew angle = 10° - 20°  
Tilt angle = 0°

DIMENSIONS

OSCILLATING MIRROR VERSION

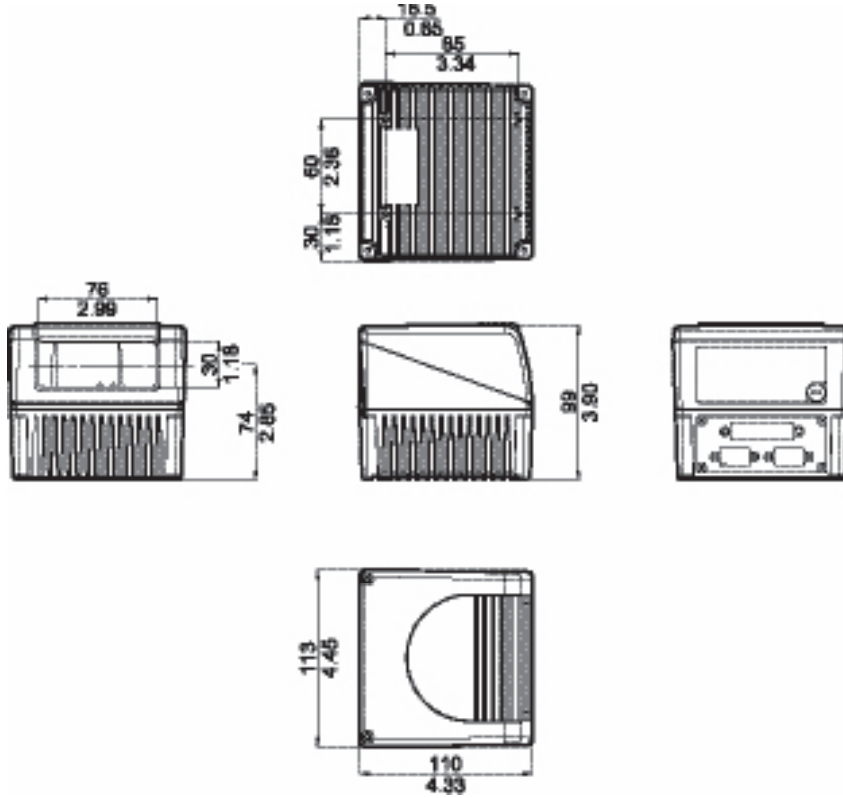

OSCILLATING MIRROR VERSION

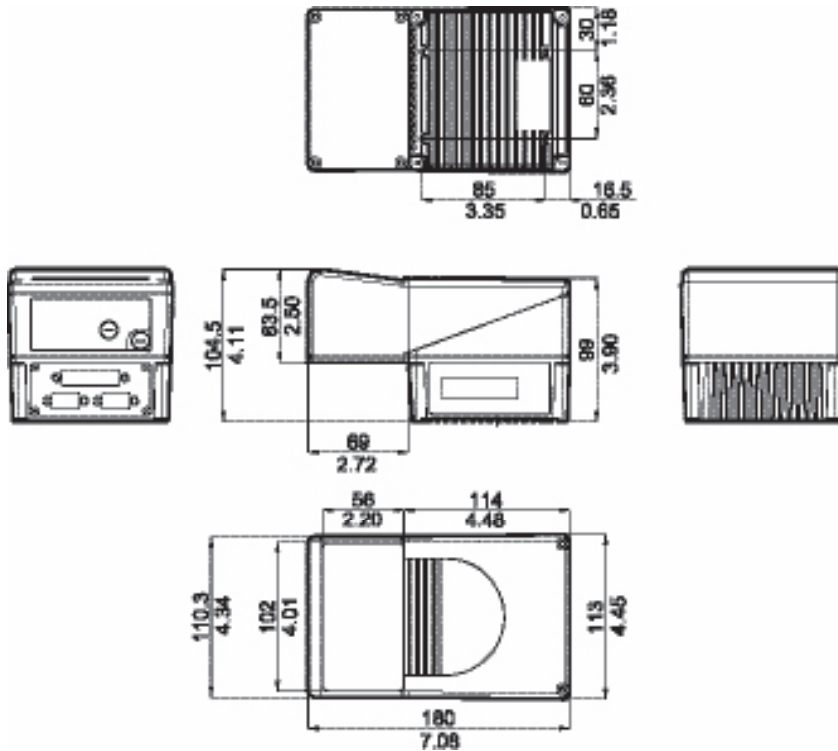

mm / inch

## ELECTRICAL CONNECTIONS

All the connectors available for each DS6300 model are the following:

SCANNER MODEL	CONNECTORS
Master/Slave	25-pin male serial interface and I/O connector 9-pin male Lonworks connector* 9-pin female Lonworks connector
Ethernet	26-pin male serial interface and I/O connector 9-pin female Lonworks connector RJ45 modular connector

The DS6300 Master/Slave models are equipped with a 25-pin male D-sub connector for connection to the host computer, power supply and input/output signals. The DS6300 Ethernet models adopt a 26-pin male connector instead of the 25-pin one.

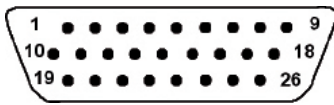

26-pin Connector

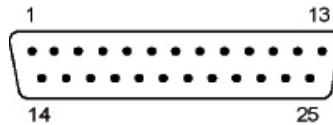

25-pin Connector

25-PIN D-SUB MALE CONNECTOR PINOUT				
Pin	Name	Function		
1	CHASSIS	Chassis - internally connected to GND Cable connected to chassis		
20	RXAUX	Receive data of auxiliary RS232 (referred to GND)		
21	TXAUX	Transmit data of auxiliary RS232 (referred to GND)		
8	OUT 1+	Configurable digital output 1 - positive pin		
22	OUT 1-	Configurable digital output 1 - negative pin		
11	OUT 2+	Configurable digital output 2 - positive pin		
12	OUT 2-	Configurable digital output 2 - negative pin		
16	OUT 3A	Configurable digital output 3 - polarity insensitive		
17	OUT 3B	Configurable digital output 3 - polarity insensitive		
18	EXT_TRIG/PS A	External trigger (polarity insensitive) for PS		
19	EXT_TRIG/PS B	External trigger (polarity insensitive) for PS		
6	IN 2/ENC A	Input signal 2 (polarity insensitive) for Encoder		
10	IN 2/ENC B	Input signal 2 (polarity insensitive) for Encoder		
14	IN 3A	Input signal 3 (polarity insensitive)		
15	IN 4A	Input signal 4 (polarity insensitive)		
24	IN_REF	Common reference of IN3 and IN4 (polarity insensitive)		
9,13	VS	Supply voltage - positive pin		
23,25,26	GND	Supply voltage - negative pin		
Pin	RS232	RS232	RS485 Full-Duplex	RS485 Half-Duplex
2	Main Interface Signals (SW Selectable)	TX	TX485 +	RTX485 +
3		RX	* RX485 +	
4		RTS	TX485 -	RTX485 -
5		CTS	* RX485 -	
7		GND_ISO	GND_ISO	GND_ISO

\* Do not leave floating, see DS6300 Reference Manual for connection details.

## ELECTRICAL CONNECTIONS

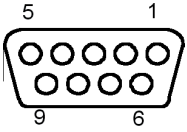

Female (all models)

9-pin Local Lonworks Connectors

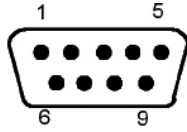

Male (Master/Slave model)

9-pin Local Lonworks Connectors

### 9-PIN LONWORKS CONNECTOR PINOUT

Pin	Name	Function
1	CHASSIS	Cable shield internally connected by capacitor to chassis
2	GND	Supply voltage - positive pin
6	VS_I/O	Supply voltage - negative pin
3	REF_I/O	Supply voltage of I/O circuit
4	SYS_ENC_I/O	Reference voltage of I/O circuit
5	SYS_I/O	System signal
7	LON A	System signal
8	LON B	Lonworks line (polarity insensitive)

In DS6300 Ethernet models a RJ45 Modular Jack is provided for Ethernet connection. This interface and the connector pinout are IEEE 802.3 10 BaseT and IEEE 802.3u 100 BaseTX compliant.

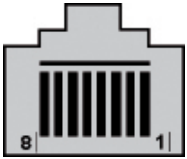

RJ45 Modular Jack

### RJ45 MODULAR JACK PINOUT

Pin	Name	Function
1	TX +	Transmitted data (+)
2	TX -	Transmitted data (-)
3	RX +	Received data (+)
6	RX -	Received data (-)
4,5,7,8	NC	Not connected

## MODELS AND ACCESSORIES

MODELS	
Order No.	Description
931351010	DS6300-100-010 ADJ FOCUS, LINEAR, M/S
931351020	DS6300-100-011 ADJ FOCUS, LINEAR, PROFIBUS
931351030	DS6300-100-012 ADJ FOCUS, LINEAR, ETHERNET
931351040	DS6300-100-015 ADJ FOCUS, LINEAR, DEVICENET
931351060	DS6300-105-010 ADJ FOCUS, OSC. MIRROR, M/S
931351070	DS6300-105-011 ADJ FOCUS, OSC. MIRROR, PROFIBUS
931351080	DS6300-105-012 ADJ FOCUS, OSC. MIRROR, ETHERNET
931351090	DS6300-105-015 ADJ FOCUS, OSC. MIRROR, DEVICENET

ACCESSORIES	
Order No.	Description
93A201100	GFC-60 90° MIRROR
93A201102	GFC-600 90° MIRROR CLOSE DISTANCE
93ACC1730	GFX-60 X-PATTERN MIRROR
93ACC1721	FBK-6000 FAST BRACKET KIT (2 PCS)

## TECHNICAL DATA

	DS6300-100-01X	DS6300-105-01X
DIMENSIONS	110 x 113 x 99 mm (4.33 x 4.45 x 3.9 in)	113 x 180 x 104.5 mm (4.45 x 7.08 x 4.11 in)
WEIGHT	1.5 kg. (3.3 lb)	2.0 kg. (4.4 lb)
CASE MATERIAL	Aluminum	
OPERATING TEMPERATURE	0 to 40 °C (32 to 104 °F),	
STORAGE TEMPERATURE	-20 to 70 °C (-4 to 158 °F)	
HUMIDITY	90% non condensing	
VIBRATION RESISTANCE	IEC 68-2-6 test FC 1.5mm; 10 to 55 Hz; 2 hours on each axis	
SHOCK RESISTANCE	IEC 68-2-27 test EA 30 G; 11 ms; 3 shocks on each axis	
PROTECTION CLASS	IP64 for standard models; IP65 on request	
LIGHT SOURCE	Visible laser diode (630 to 680 nm)	
SCANNING SPEED	600 to 1200 scan/s SW programmable	
RESOLUTION	Down to 0.20 mm (8 mils)	
READABLE SYMBOLOGIES	Code 2/5, Code39, Code93, Code128, EAN/UPC, EAN128, Codabar, Pharmacode, ISBN128	
MULTILABEL READING	Up to 10 different symbologies during the same reading phase	
COMMUNICATION INTERFACES	Main Port: RS232/RS485 up to 115.2 Kbit/s	
	Auxiliary Port: RS232 up to 115.2 Kbit/s	
OTHER AVAILABLE INTERFACES	Lonworks (Master/Slave), Ethernet, Profibus, DeviceNet	
DIGITAL INPUTS	Four SW programmable, optocoupled, NPN/PNP	
DIGITAL OUTPUTS	Three SW programmable, optocoupled, event driven	
DISPLAY & KEYPAD	LCD 16 x 2 characters & 3 keys	
LED INDICATORS	Power On, Phase On, Data Tx	
DEVICE PROGRAMMING	Windows™ based SW (Genius™) via serial or Ethernet link	
	Serial Host Mode Programming sequences	
OPERATING MODES	'On-line', 'Serial On-line', 'Automatic', 'Continuous', 'Test'	
LASER CLASSIFICATION	Class 2 - EN60825-1; Class II - CDRH	
LASER CONTROL	Safety system to turn laser off in cases of motor slowdown or failure	
POWER SUPPLY	15 to 30 VDC	
POWER CONSUMPTION	15 W typical, 20 W max	